

40 Watts

- Low profile 0.75" and 3 x 2" footprint
- PCB mount option
- -40 to 70°C operation
- ITE approval EN60950-1
- Cover kit available
- EN55032 Level B conducted & radiated
- 5 Year warranty

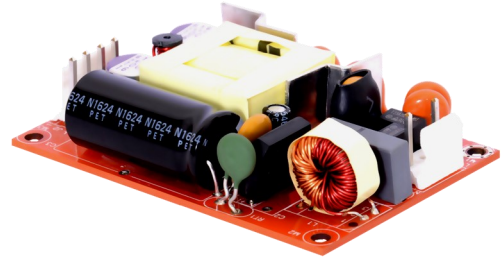

The ULP40 series of low profile, open frame AC-DC power modules offer up to 40W convection cooled in a standard 3" x 2" package. They are chassis mount with screw terminals or Tyco headers, alternatively PCB mountable option. They are low noise, low no load (<0.3W), have a cover kit option, have a wide operating temperature of -40 to 70°C, in a range of voltages from 5V to 58V and all come with a FiDUS 5 year warranty.

Dimensions:

3 x 2 x 0.75" (76.2 x 50.8 x 19.05mm)

Models & Ratings

INSTALLATION ADVICE PG5

Model Number ⁽¹⁾	Output Power	Output voltage ⁽⁴⁾	Output Current
ULP40-1 <u>3</u> 05	25W	5V	5.00A
ULP40-1 <u>3</u> 12	40W	12V	3.33A
ULP40-1 <u>3</u> 15	40W	15V	2.67A
ULP40-1 <u>3</u> 24	40W	24V	1.67A
ULP40-1 <u>3</u> 30	40W	30V	1.33A
ULP40-1 <u>3</u> 48	40W	48V	0.83A

Notes

1. For screw terminal version replace 3 above for 0. Example 'ULP40-1005' for PCB mount through hole version change 3 above for 2. Example 'ULP40-1205'
2. At 100% load, 230VAC

3. Cover kit available ULP40-CK derates unit to 70% output
4. 58V version available. Please contact sales.

Key specifications

Parameter	Minimum	Typical	Maximum	Units	Notes & Conditions
AC Input range	85		264	VAC	No derating
Operating temperature	-40		70	°C	See derating curve p3. Ripple can be 10% or more between -40 and 0°C, start-up guaranteed.
Efficiency	85% typical				
Dimensions	3 x 2 x 0.75" (76.2 x 50.8 x 19.05mm)				
EMC	EN55032 Level B conducted and radiated (with king core K5B RC 25x12x15-M ferrite) EN61000-3 and EN61000-4, harmonics, flicker, Surge, EFT, ESD, conducted and radiated.				
Safety	IEC60950-1, EN60950-1, UL60950-1, CSA22.2 No 60950-1, CE.				

Input

Parameter	Minimum	Typical	Maximum	Units	Notes & Conditions
Input voltage	85		264	VAC	No derating
Input frequency	47		63	Hz	
Input current (rms)			0.8	A	At 115VAC
			0.4		At 230VAC
Inrush current			<25	A	115VAC cold start at 25°C
			<45		230VAC cold start at 25°C
No load input power			<0.3	W	

Output

Parameter	Minimum	Typical	Maximum	Units	Notes & Conditions
Output voltage	5		58	VDC	See Model & Ratings table
Set point accuracy			±2/3	%	3% for 5V model
Line regulation			±0.5	%	
Load regulation			±1	%	
Minimum load	0			%	
Leakage current		300		uA	
Transient response			4	%	25% step change 0.1A/uS slew 50% duty 50Hz in <5ms
Ripple & Noise			1 / 1.5	%	All models measured with 0.1uF ceramic and 10uF electrolytic capacitor. 20 MHz bandwidth. At rated line and full load. 1.5% for 5V unit
Hold up time		60		ms	At full load at 230VAC
Overload protection		110		%	Automatic recovery
Short circuit protection					Trip and restart. Automatic recovery
Overvoltage protection	110		140	%	Latching, requires manual power reset.

General

Parameter	Minimum	Typical	Maximum	Units	Notes & Conditions
Efficiency		85		%	
Isolation: Input to Output	4242			VDC	
Switching frequency		65		KHz	
Power density			8.8	W/In ³	
MTBF	>2			MHrs	As per Telcordia-SR332– issue 3
Weight		100		g	

Environmental

Parameter	Minimum	Typical	Maximum	Units	Notes & Conditions
Operating temperature	-40		70	°C	Derate above 50°C at 2.5% per °C Please see derating curve on page 3
Storage temperature	-40		85	°C	
Cooling					Convection cooled
Altitude	16000		40000	ft	16000 operating 40000 non operating
Humidity	5		95	% RH	Non condensing

Derating curve

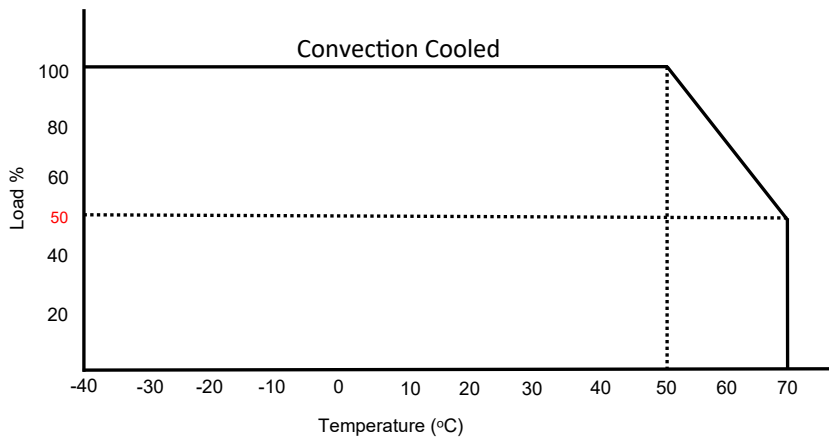

EMC: Emissions

	Standard	Test level	Criteria	Notes & Conditions
Conducted	EN55032	B		CISPR22-B, FCC PART15-B
Radiated	EN55032	B		With ferrite king core K5B RC 25x12x15-M on input
Harmonic current	EN61000-3-2	Class D		
Voltage flicker	EN61000-3-3			

EMC: Immunity

	Standard	Test level	Criteria	Notes & Conditions
ESD	EN61000-4-2	3	A	±6 contact, ±8 air.
Radiated	EN61000-4-3	3	A	10V/m 80MHz-2.7GHz sine wave 80% AM 1KHz
EFT	EN61000-4-4	3	A	2KV Power, 1KV I/O 5KHz
Surges	EN61000-4-5	Installation Class 3	A	1KV Live-Neutral, 2KV Live/Neutral—Earth
Conducted	EN61000-4-6	3	A	10V, 0.15 to 80MHz sine wave 80AM 1KHz
Magnetic Fields	EN61000-4-8	3	A	10A/m
Voltage Dips and Interruptions	EN61000-4-11		A,B	

Safety Approvals

	Safety standard	Notes & Conditions
UL/CSA	UL60950-1 2nd Ed., CSA 22.2 No 60950-1-07 2nd Ed.	E150565
CB	IEC60950-1 2nd Ed. 2006/A2:2013	Test cert NO95863
EU	EN60950-1 2nd Ed. 2006/A2:2013	Nemko No P17221712
CE		2011/65/EU RoHS Directive and 2014/35/EU Low voltage directive
Equipment protection class		Class I

Mechanical Details

Tyco header

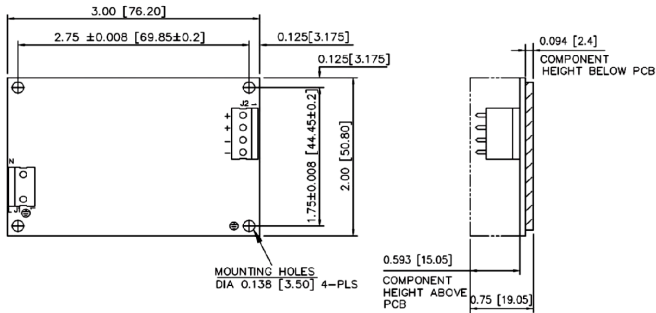

PCB through hole mount

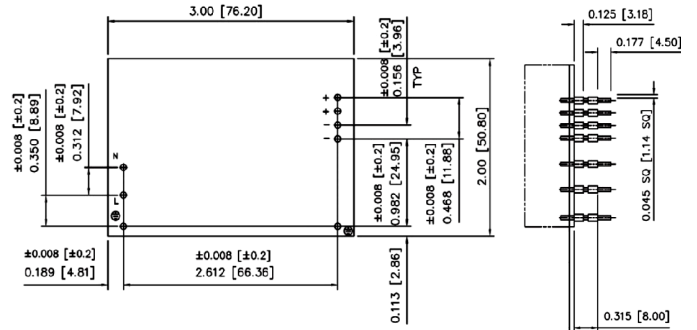

Screw terminal

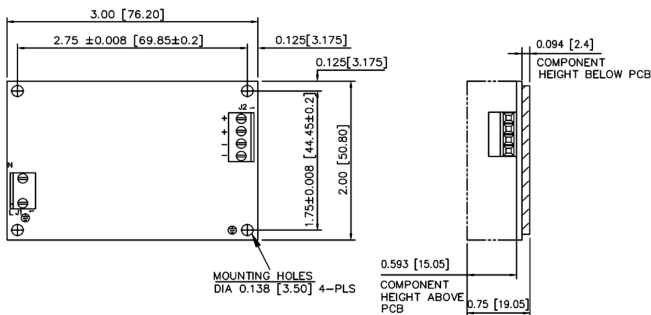

J1: Input Connector ⁽²⁾	
Pin Connections	
Pin	Function
1	AC Line
2	AC Neutral

J2: Output Connector ⁽³⁾	
Pin Connections	
Pin	Function
1	+Vout
2	+Vout
3	-Vout
4	-Vout

ULP40-CK case

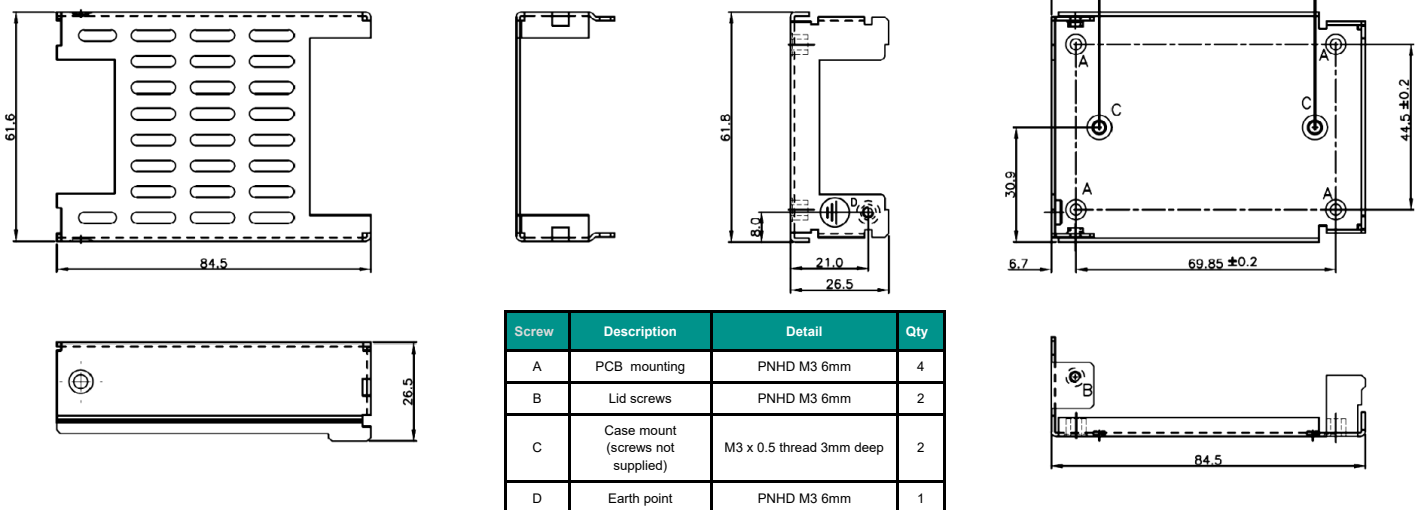

Notes

1. All dimensions shown in Inches [mm] ±0.042 [±1.0mm]
2. J1: Input connector details for Tyco version: 640445-3 mating part: 647402-3
3. J2: Output connector details for Tyco version: 640445-4 mating part: 647402-4
4. Maximum OD of stand off 5.4mm
5. Case includes mylar insulator
6. Case derates unit to 70% output power

Installation Advice

Safety

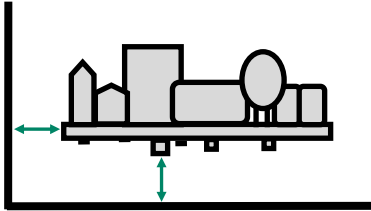

On installation customers must consider the required creepage and clearance distances between the PSU and the end-equipment enclosure. These distances vary depending on the installation class and safety standard requirements.

For **Class I** installations there should be 3-4mm between any part of the PSU and any earthed metal part of the enclosure. 3mm is acceptable for IT applications, 4mm required for medical applications. In Class I installations the PSU earth point must be connected to system safety ground.

For **Class II** installations distances may need to be increased if being installed into a surrounding metal enclosure.

Ensure consideration of components on the underside of the PCB or low lying spills when measuring clearance distances between the PSU and the end-equipment. Also top surface especially in tight enclosures such as 1U boxes. An insulation material can be used between PSU and metal if smaller gap required.

FiDUS recommends installing the PSU on 6mm stand offs typically, but check the distances.

EMC

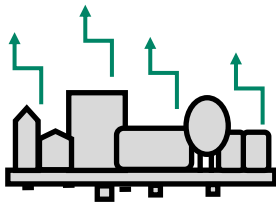

Conducted and radiated emissions compliance is a common application consideration. It is important to remember that even when using a properly filtered PSU, an application may still not achieve compliance if it is not designed to minimise emissions. That being said, there are a number of things that can be done to optimise EMC performance either as best practice, or if you are struggling for compliance:

- 1) Connect all marked EMI ground points to earth. Often these are combined with the safety earth point (in class I installations), but on some power supplies there may be additional earth tags or mounting points.
- 2) Minimise the length of input/output wiring where possible and try to maintain max distance of the conductors from the PSU, to prevent noise pick up. Avoid bundling input and output cables together. A common component to avoid placing wiring near is the PFC inductor in power factor corrected power supplies.
- 3) Apply additional filtering before the PSU input (ensure consideration of which frequencies there are issues with before selecting a filter).
- 4) When using an open frame PSU, mount the supply on a metal plate and connect EMI mounting points.
- 5) In multi circuit systems, decouple the circuits locally.
- 6) Ferrites added between the PSU and system input connector and/or the DC output cables can help in reducing radiated noise issues in systems. If seen, issues are commonly in the 30-150MHz area.

For more detailed assistance, if you still have any concerns with compliance, please get in contact with our Engineering department who are on hand to assist with any queries.

Thermal

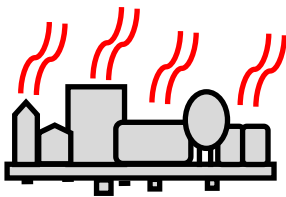

Thermal management is an important consideration when thinking about equipment service life. Electrolytic capacitors within the PSU wear with time and are typically the first end-of-life failure. Keeping the operation temperature of key components within the PSU, such as the electrolytic capacitors, as low as possible is paramount. As a general rule, for every 10°C drop in the operating temperature of the electrolytic capacitors you double their lifetime, and thus the lifetime of the power supply. When looking at thermal performance it is helpful to test under a worst-case set of conditions, to ensure component temperatures are in an acceptable range for the required service life. Then consider the impact of operational time, load and temperature profile to estimate a more realistic lifetime for your PSU.

Also, many FiDUS power supplies offer a *Peak Power* rating to provide for customers with pulsing loads. When using a peak power capability customers must consider:

- 1) Peak duration rating: the maximum length of time the peak can be drawn for
- 2) Duty cycle: the frequency with which the peak can be drawn. (e.g. 10% duty cycle, 1 second on:9 seconds off)
- 3) Average power value: datasheets will state the maximum average power acceptable with peak power PSUs. If any of these elements are exceeded the supply may overheat, with performance and lifetime suffering as a result.

Connectivity

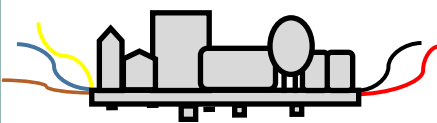

All FiDUS Power engineering samples requested will arrive with a free of charge loom kit for ease of testing.

The loom kit connects to the input/output terminals of the PSU and provides the customer with bare wire ends to connect with.

The loom kits can also prove advantageous for ease of installation in production. Please contact sales if you are interested in including the loom kit in your quotation.

Alternatively the input/output connector and mating part details can be found in the attached table.

	Part Number	Mating Part Number
Input	Tyco: 640445-3	Tyco: 647402-3
Output	Tyco: 640445-4	Tyco: 647402-4
Loom Kit	ULP40-LK	